





Chapter 2 Part C:

Zetec engine in-car repair procedures

Contents

Auxiliary drivebelt check and renewal	See Chapter 1	Engine/transmission mountings - inspection and renewal	16
Camshaft oil seals - renewal	10	Flywheel/driveplate - removal, inspection and refitting	17
Camshafts and hydraulic tappets - removal, inspection and refitting	11	General information	1
Compression test - description and interpretation	2	Oil pump - removal, inspection and refitting	14
Crankshaft oil seals - renewal	15	Sump - removal and refitting	13
Crankshaft pulley - removal and refitting	6	Timing belt - removal, refitting and adjustment	8
Cylinder head - removal and refitting	12	Timing belt covers - removal and refitting	7
Cylinder head cover - removal and refitting	4	Timing belt tensioner and sprockets - removal, inspection and refitting	9
Engine oil and filter renewal	See Chapter 1	Top Dead Centre (TDC) for No 1 piston - locating	3
Engine oil level check	"Weekly Checks"	Valve clearances - general information	5

Degrees of difficulty

Easy , suitable for novice with little experience 	Fairly easy , suitable for beginner with some experience 	Fairly difficult , suitable for competent DIY mechanic 	Difficult , suitable for experienced DIY mechanic 	Very difficult , suitable for expert DIY or professional 
---	--	--	---	--

Specifications

2C

General

Engine type	Four-cylinder, in-line, double overhead camshafts
Engine code:	
1.6 litre models	L1G
1.8 litre models	RDB or RQC
Capacity:	
1.6 litre models	1597 cc
1.8 litre models	1796 cc
Bore:	
1.6 litre models	76.0 mm
1.8 litre models	80.6 mm
Stroke - all models	88.0 mm
Compression ratio:	
1.6 litre models	10.3:1
1.8 litre models	10.0:1
Firing order	1-3-4-2 (No 1 cylinder at timing belt end)
Direction of crankshaft rotation	Clockwise (seen from right-hand side of vehicle)

Cylinder head

Hydraulic tappet bore inside diameter	28.395 to 28.425 mm
---	---------------------

Camshafts and hydraulic tappets

Camshaft bearing journal diameter	25.960 to 25.980 mm
Camshaft bearing journal-to-cylinder head running clearance	0.020 to 0.070 mm
Camshaft endfloat	0.080 to 0.220 mm

Lubrication

Engine oil type/specification	See "Lubricants, fluids and tyre pressures"
Engine oil capacity	See "Lubricants, fluids and tyre pressures"
Oil pressure:	
Idling	1.3 to 2.5 bar
At 4000 rpm	3.7 to 5.5 bars
Oil pump clearances	Not specified

Torque wrench settings	Nm	lbf ft
Cylinder head cover bolts:		
Stage 1	2	1.5
Stage 2	7	5
Camshaft sprocket bolts	68	50
Camshaft bearing cap bolts:		
Stage 1	9	7
Stage 2	19	14
Cylinder head bolts:		
Stage 1	24	18
Stage 2	45	33
Stage 3	Angle-tighten a further 105°	
Timing belt cover fasteners:		
Upper-to-middle (outer) cover bolts	4	3
Cover-to-cylinder head or block bolts	7	5
Cover studs-to-cylinder head or block	9	7
Timing belt tensioner bolt	38	28
Timing belt tensioner backplate locating peg	9	7
Timing belt tensioner spring retaining pin	9	7
Timing belt guide pulley bolts	38	28
Water pump pulley bolts	9	7
Auxiliary drivebelt idler pulley	47	35
Front engine lifting eye bolt	16	12
Exhaust manifold heat shield bolts:		
Shield-to-cylinder head	7	5
Shield/dipstick tube	9	7
Shield/coolant pipe-to-manifold	23	17
Crankshaft pulley bolt	115	85
Oil pump-to-cylinder block bolts	10	7
Oil pick-up pipe-to-pump screws	10	7
Oil baffle/pump pick-up pipe nuts	19	14
Oil filter adapter-to-pump	22	16
Oil pressure warning light switch	27	20
Sump bolts	20	15
Coolant pipe-to-sump bolt	9	7
Flywheel/driveplate bolts	110	81
Crankshaft left-hand oil seal carrier bolts	22	16
Engine mountings:		
Engine front right-hand mounting:		
Alternator mounting bracket-to-cylinder block bolts	41 to 58	30 to 43
Mounting bracket-to-alternator mounting bracket bolts	Not available	Not available
Mounting through-bolt	Not available	Not available
Outer bracket-to-mounting bolts	58 to 79	43 to 58
Inner bracket-to-body bolts	58 to 79	43 to 58
Outer bracket-to-body bolts	58 to 79	43 to 58
Engine rear right-hand mounting:		
Bracket-to-cylinder block bolts	76 to 104	56 to 77
Mounting-to-(cylinder block) bracket bolts	71 to 98	52 to 72
Mounting-to-body bolt and nut	102 to 138	75 to 102
Transmission mounting fasteners	Refer to Chapter 7A or 7B	

Note: Refer to Part D of this Chapter for remaining torque wrench settings.

1 General information

How to use this Chapter

This Part of Chapter 2 is devoted to repair procedures possible while the engine is still installed in the vehicle, and includes only the Specifications relevant to those procedures. Similar information concerning the 1.3 litre HCS engines, and the 1.4 and 1.6 litre CVH and PTE engines, will be found in Parts A and B of this Chapter respectively. Since

these procedures are based on the assumption that the engine is installed in the vehicle, if the engine has been removed from the vehicle and mounted on a stand, some of the preliminary dismantling steps outlined will not apply.

Information concerning engine/transmission removal and refitting, and engine overhaul, can be found in Part D of this Chapter, which also includes the Specifications relevant to those procedures.

Engine description

The Zetec engine, (formerly Zeta), is of sixteen-valve, double overhead camshaft

(DOHC), four-cylinder, in-line type, mounted transversely at the front of the vehicle, with the transmission on its left-hand end.

Apart from the plastic timing belt covers and the cast-iron cylinder block/crankcase, all major engine castings are of aluminium alloy.

The crankshaft runs in five main bearings, the centre main bearing's upper half incorporating thrustwashers to control crankshaft endfloat. The connecting rods rotate on horizontally-split bearing shells at their big-ends. The pistons are attached to the connecting rods by gudgeon pins which are an interference fit in the connecting rod small-end eyes. The aluminium alloy pistons are

fitted with three piston rings: two compression rings and an oil control ring. After manufacture, the cylinder bores and piston skirts are measured and classified into three grades, which must be carefully matched together, to ensure the correct piston/cylinder clearance; no oversizes are available to permit reboring.

The inlet and exhaust valves are each closed by coil springs; they operate in guides which are shrink-fitted into the cylinder head, as are the valve seat inserts.

Both camshafts are driven by the same toothed timing belt, each operating eight valves via self-adjusting hydraulic tappets, thus eliminating the need for routine checking and adjustment of the valve clearances. Each camshaft rotates in five bearings that are line-bored directly in the cylinder head and the (bolted-on) bearing caps; this means that the bearing caps are not available separately from the cylinder head, and must not be interchanged with caps from another engine.

The water pump is bolted to the right-hand end of the cylinder block, inboard of the timing belt, and is driven with the power steering pump and alternator by a flat "polyvee"-type auxiliary drivebelt from the crankshaft pulley.

When working on this engine, note that Torx-type (both male and female heads) and hexagon socket (Allen head) fasteners are widely used; a good selection of bits, with the necessary adapters, will be required, so that these can be unscrewed without damage and, on reassembly, tightened to the torque wrench settings specified.

Lubrication is by means of an eccentric-rotor trochoidal pump, which is mounted on the crankshaft right-hand end, and draws oil through a strainer located in the sump. The pump forces oil through an externally-mounted full-flow cartridge-type filter - on some versions of the engine, an oil cooler is fitted to the oil filter mounting, so that clean oil entering the engine's galleries is cooled by the main engine cooling system.

Repair operations possible with the engine in the car

The following work can be carried out with the engine in the car:

- a) Compression pressure - testing.
- b) Cylinder head cover - removal and refitting.
- c) Timing belt covers - removal and refitting.
- d) Timing belt - renewal.
- e) Timing belt tensioner and sprockets - removal and refitting.
- f) Camshaft oil seals - renewal.
- g) Camshafts and hydraulic tappets - removal and refitting.
- h) Cylinder head - removal and refitting.
- i) Cylinder head and pistons - decarbonising.
- j) Sump - removal and refitting.
- k) Crankshaft oil seals - renewal.
- l) Oil pump - removal and refitting.

m) Flywheel/driveplate - removal and refitting.

n) Engine/transmission mountings - removal and refitting.

Note: It is possible to remove the pistons and connecting rods (after removing the cylinder head and sump) without removing the engine. However, this is not recommended. Work of this nature is more easily and thoroughly completed with the engine on the bench, as described in Chapter 2D.

2 Compression test - description and interpretation

Refer to Section 2 in Part A of this Chapter.

3 Top Dead Centre (TDC) for No 1 piston - locating

1 Top dead centre (TDC) is the highest point of the cylinder that each piston reaches as the crankshaft turns. Each piston reaches its TDC position at the end of its compression stroke, and then again at the end of its exhaust stroke. For the purpose of engine timing, TDC on the compression stroke for No 1 piston is used. No 1 cylinder is at the timing belt end of the engine. Proceed as follows.

2 Disconnect the battery negative (earth) lead (refer to Chapter 5A, Section 1).

3 Chock the rear wheels then jack up the front of the car and support it on axle stands (see "Jacking and Vehicle Support"). Remove the right-hand roadwheel.

4 Remove the auxiliary drivebelt cover (see Chapter 1) to expose the crankshaft pulley and timing marks.

5 Fit a spanner onto the crankshaft pulley bolt, and turn the crankshaft in its normal direction of rotation (clockwise, viewed from the pulley end).



Turning the engine will be easier if the spark plugs are removed first - see Chapter 1.

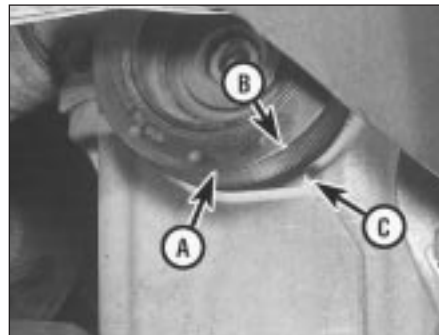

3.6a Do not use crankshaft pulley's first pair of notches "A" - align second pair of notches "B" with raised rib on sump "C" . . .

6 Note the two pairs of notches in the inner and outer rims of the crankshaft pulley. In the normal direction of crankshaft rotation the first pair of notches are irrelevant to the vehicles covered in this manual, while the second pair indicate TDC when aligned with the rear edge of the raised mark on the sump. Rotate the crankshaft clockwise until the second pair of notches align with the edge of the sump mark; use a straight edge extended out from the sump if greater accuracy is required (see illustrations).

7 Nos 1 and 4 cylinders are now at TDC, one of them on the compression stroke. Remove the oil filler cap; if No 4 cylinder exhaust cam lobe is pointing to the rear of the vehicle and slightly downwards, it is No 1 cylinder that is correctly positioned. If the lobe is pointing horizontally forwards, rotate the crankshaft one full turn (360°) clockwise until the pulley notches align again, and the lobe is pointing to the rear and slightly down. No 1 cylinder will then be at TDC on the compression stroke.

8 Once No 1 cylinder has been positioned at TDC on the compression stroke, TDC for any of the other cylinders can then be located by rotating the crankshaft clockwise 180° at a time and following the firing order (see Specifications).

9 With the engine set at No 1 piston on TDC compression, refit the drivebelt cover and the roadwheel, then lower the vehicle and refit the spark plugs.

4 Cylinder head cover - removal and refitting

Removal

1 Disconnect the battery negative (earth) lead (refer to Chapter 5A, Section 1).

2 Remove the air inlet components as necessary for access as described in the Chapter 4D.

3 Disconnect the accelerator cable from the throttle linkage as described in Chapter 4D.

4 On models equipped with power steering, release the high pressure fluid pipe from the



3.6b . . . use a straight edge extended out from the sump (arrowed) if greater accuracy is required



4.6 Disconnecting crankcase breather hose from cylinder head cover union



4.8 Removing cylinder head cover



4.10 Ensure gasket is located correctly in cover groove

clamp brackets and disconnect the pipe joint union over the top of the cylinder head cover. Place absorbent rags beneath the union as it is disconnected to soak up escaping fluid and plug the open unions to prevent dirt entry and further fluid loss. Move the pipe(s) clear just sufficiently to allow removal of the cylinder head cover.

5 Remove the timing belt upper cover (see Section 7).

6 Disconnect the crankcase breather hose from the cylinder head cover union (see illustration).

7 Unplug the HT leads from the spark plugs and withdraw them, unclipping the leads from the cover.

8 Working progressively, unscrew the cylinder head cover retaining bolts, noting the spacer sleeve and rubber seal at each, then withdraw the cover (see illustration).

9 Discard the cover gasket; this *must* be renewed whenever it is disturbed. Check that the sealing faces are undamaged, and that the rubber seal at each retaining bolt is serviceable; renew any worn or damaged seals.

Refitting

10 On refitting, clean the cover and cylinder head gasket faces carefully, then fit a new gasket to the cover, ensuring that it locates correctly in the cover grooves (see illustration).

11 Refit the cover to the cylinder head, then insert the rubber seal and spacer sleeve at each bolt location (see illustration). Start all

bolts finger-tight, ensuring that the gasket remains seated in its groove.

12 Working in a diagonal sequence from the centre outwards, and in two stages (see Specifications), tighten the cover bolts to the specified torque wrench setting.

13 Refit the HT leads, clipping them into place so that they are correctly routed; each is numbered, and can also be identified by the numbering on its respective coil terminal.

14 Reconnect the crankcase breather hose, and refit the timing belt upper cover. Reconnect and adjust the accelerator cable, then refit the air inlet components (see Chapter 4B).

15 On models with power steering, reconnect the high pressure fluid pipe then bleed the system as described in Chapter 10.

5 Valve clearances - general information

Refer to Section 5 in Part B of this Chapter.

6 Crankshaft pulley - removal and refitting

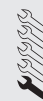

Removal

1 Remove the auxiliary drivebelt - either remove the drivebelt completely, or just



4.11 Ensure rubber seal is fitted to each cover bolt spacer, as shown



6.9 Unscrew pulley bolt to release crankshaft pulley

secure it clear of the crankshaft pulley, depending on the work to be carried out (see Chapter 1).

2 If necessary, rotate the crankshaft until the timing marks align (see Section 3).

3 The crankshaft must now be locked to prevent its rotation while the pulley bolt is unscrewed. To do this, remove the starter motor (Chapter 5A) and lock the starter ring gear teeth using a suitable screwdriver.

4 It should now just be possible to reach between the crankshaft pulley and the body side member to undo and remove the pulley bolt and withdraw the pulley. However, if additional working clearance is needed, proceed as follows.

5 If not already done, chock the rear wheels then jack up the front of the car and support it on axle stands (see "Jacking and Vehicle Support"). Remove the front right-hand roadwheel.

6 Support the weight of the engine/transmission using a trolley jack, with a wooden spacer to prevent damage to the sump.

7 From above, unscrew the three bolts securing the engine's front right-hand (Y-shaped) mounting bracket to the alternator mounting bracket. Unfasten the engine's rear right-hand mounting from the body by unscrewing first the single nut (and washer) immediately to the rear of the timing belt cover, then the bolt in the wheel arch

8 With the engine's right-hand mountings unfastened from the body, lower the engine/transmission on the jack until a socket spanner can be fitted to the crankshaft pulley bolt.

9 With the starter ring gear teeth locked, unscrew the crankshaft pulley bolt and withdraw the pulley (see illustration).

Refitting

10 Refitting is the reverse of the removal procedure; ensure that the pulley's keyway is aligned with the crankshaft's locating key, and tighten the pulley bolt to the specified torque wrench setting. If the engine mountings were disturbed, use the jack to adjust the height of the engine/transmission until the bolts (and nut, with washer) can be refitted and screwed

home by hand, then tighten them securely, to the specified torque wrench settings, where given.

11 Refit the auxiliary drivebelt as described in Chapter 1 on completion.

7 Timing belt covers - removal and refitting



Upper cover

1 Unscrew the cover's two mounting bolts and withdraw it (see illustration).

2 Refitting is the reverse of the removal procedure; ensure that the cover edges engage correctly with each other, and note the torque wrench setting specified for the bolts.

Middle cover

3 Slacken the water pump pulley bolts.

4 Remove the timing belt upper cover.

5 Remove the auxiliary drivebelt (see Chapter 1).

6 Unbolt and remove the water pump pulley.

7 Unscrew the middle cover fasteners (one bolt at the front, one at the lower rear, one stud at the top rear) and withdraw the cover.

8 Refitting is the reverse of the removal procedure. Ensure that the cover edges engage correctly with each other, and note the torque wrench settings specified for the various fasteners.

Lower cover

9 Slacken the water pump pulley bolts.

10 Remove the crankshaft pulley (see Section 6) then unbolt and remove the water pump pulley.

11 Unscrew the three cover securing bolts, and withdraw it (see illustration).

12 Refitting is the reverse of the removal procedure; ensure the cover edges engage correctly with each other, and note the torque wrench settings specified for the various fasteners.

Inner shield

13 Remove the timing belt, its tensioner components and the camshaft sprockets (see Sections 8 and 9).

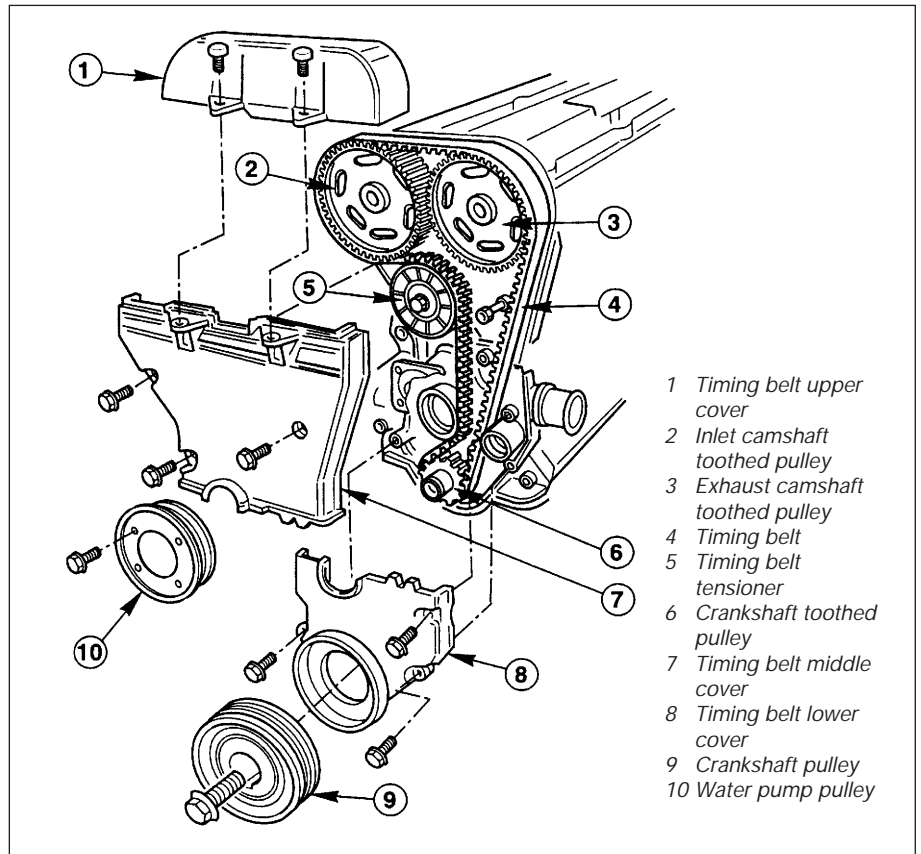

7.1 Timing belt and cover details

14 The shield is secured to the cylinder head by two bolts at the top, and by two studs lower down; unscrew these and withdraw the shield (see illustration).

15 Refitting is the reverse of the removal procedure; note the torque wrench settings specified for the various fasteners.

8 Timing belt - removal, refitting and adjustment



Note: To carry out this operation, a new timing belt (where applicable), a new cylinder head cover gasket, and some special tools (see text)

will be required. If the timing belt is being removed for the first time since the vehicle left the factory, a tensioner spring and retaining pin must be obtained for fitting on reassembly.

Removal

1 Disconnect the battery negative (earth) lead (refer to Chapter 5A, Section 1).

2 Slacken the water pump pulley bolts.

3 Remove the cylinder head cover (see Section 4).

4 Remove the spark plugs, covering their holes with clean rag, to prevent dirt or other foreign bodies from dropping in (see Chapter 1).

5 Remove the auxiliary drivebelt (see Chapter 1).

6 Position the engine with No 1 piston at TDC on compression as described in Section 3.

7 Unbolt and remove the water pump pulley and, where fitted, the auxiliary drivebelt idler pulley.

8 Obtain Ford service tool 21-162, or fabricate a substitute alternative from a strip of metal 5 mm thick (while the strip's thickness is critical, its length and width are not, but should be approximately 180 to 230 mm by 20 to 30 mm). Check that Nos 1 and 4 cylinders are at TDC - No 1 on the compression stroke - by resting this tool on the cylinder head mating surface, and sliding



7.11 Removing timing belt lower cover - bolt locations arrowed

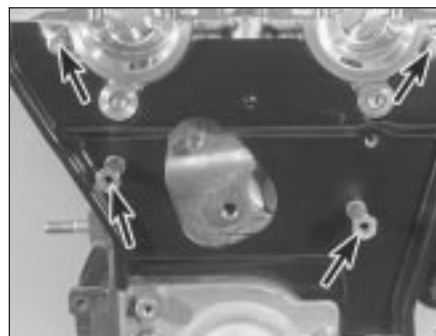

7.14 Timing belt inner shield fasteners (arrowed)



8.8 Fit camshaft-aligning tool to ensure engine is locked with Nos 1 and 4 cylinders at TDC

it into the slot in the left-hand end of both camshafts (see illustration). The tool should slip snugly into both slots while resting on the cylinder head mating surface; if one camshaft is only slightly out of alignment, it is permissible to use an open-ended spanner to rotate the camshaft gently and carefully until the tool will fit.

9 If both camshaft slots (they are machined significantly off-centre) are below the level of the cylinder head mating surface, rotate the crankshaft through one full turn clockwise and fit the tool again; it should now fit as described in the previous paragraph.

10 With the camshaft aligning tool remaining in place, remove the crankshaft pulley. *Do not* use the locked camshafts to prevent the crankshaft from rotating - use only the locking method described in Section 6.

11 Remove the timing belt lower and middle covers (see Section 7).

12 With the camshaft-aligning tool still in place, slacken the tensioner bolt, and use an Allen key inserted into its centre to rotate the tensioner clockwise as far as possible away from the belt; retighten the bolt to secure the tensioner clear of the timing belt (see illustration).

13 If the timing belt is to be re-used, use white paint or similar to mark its direction of rotation, and note from the manufacturer's markings which way round it is fitted. Withdraw the belt. *Do not* rotate the crankshaft until the timing belt is refitted.



8.17a Fitting tensioner spring retaining pin



8.12 Slacken tensioner bolt, and use Allen key to rotate tensioner away from timing belt

14 If the belt is being removed for reasons other than routine renewal, check it carefully for any signs of uneven wear, splitting, cracks (especially at the roots of the belt teeth) or contamination with oil or coolant. Renew the belt if there is the slightest doubt about its condition. As a safety measure, the belt must be renewed as a matter of course at the intervals given in Chapter 1; if its history is unknown, the belt should be renewed irrespective of its apparent condition whenever the engine is overhauled. Similarly, check the tensioner spring (where fitted), renewing it if there is any doubt about its condition. Check also the sprockets for signs of wear or damage, and ensure that the tensioner and guide pulleys rotate smoothly on their bearings; renew any worn or damaged components. If signs of oil or coolant contamination are found, trace the source of the leak and rectify it, then wash down the engine timing belt area and related components, to remove all traces of oil or coolant.

Refitting and adjustment

15 On reassembly, temporarily refit the crankshaft pulley, to check that the crankshaft is still positioned at TDC for No 1 piston on compression, then ensure that both camshafts are aligned at TDC by the special tool (paragraph 8). If the engine is being reassembled after major dismantling, both camshaft sprockets should be free to rotate

on their respective camshafts; if the timing belt alone is being renewed, both sprockets should still be securely fastened.

16 A holding tool will be required to prevent the camshaft sprockets from rotating while their bolts are slackened and retightened; either obtain Ford service tool 15-030A, or fabricate a suitable substitute (see Tool Tip).

Note: *Do not use the camshaft-aligning tool (whether genuine Ford or not) to prevent rotation while the camshaft sprocket bolts are slackened or tightened; the risk of damage to the camshaft concerned and to the cylinder head is far too great. Use only a forked holding tool applied directly to the sprockets, as described.*

TOOL TIP

To make a camshaft sprocket holding tool, obtain two lengths of steel strip about 6 mm thick by 30 mm wide or similar, one 600 mm long, the other 200 mm long (all dimensions approximate). Bolt the two strips together to form a forked end, leaving the bolt slack so that the shorter strip can pivot freely. At the end of each "prong" of the fork, bend the strips through 90° about 50 mm from their ends to act as the fulcrums; these will engage with the holes in the sprockets. It may be necessary to grind or cut off their sides slightly to allow them to fit the sprocket holes (see illustration 8.23).

17 If it is being fitted for the first time, screw the timing belt tensioner spring retaining pin into the cylinder head, tightening it to the specified torque wrench setting. Unbolt the tensioner, hook the spring on to the pin and the tensioner backplate, then refit the tensioner, engaging its backplate on the locating peg (see illustrations).

18 In all cases, slacken the tensioner bolt (if necessary), and use an Allen key inserted into its centre to rotate the tensioner as far as possible against spring tension, then retighten the bolt to secure the tensioner (see illustration).



8.17b Hook spring onto tensioner and fit as shown - engage tensioner backplate on locating peg (arrowed) . . .



8.18 . . . then use Allen key to position tensioner so that timing belt can be refitted



8.20 Slacken tensioner bolt to give initial belt tension



8.23 Using forked holding tool while camshaft toothed pulley bolt is tightened



8.24 When setting is correct, tighten tensioner bolt to specified torque wrench setting

19 Fit the timing belt; if the original is being refitted, ensure that the marks and notes made on removal are followed, so that the belt is refitted the same way round, and to run in the same direction. Starting at the crankshaft sprocket, work anti-clockwise around the camshaft sprockets and tensioner, finishing off at the rear guide pulley. The front run, between the crankshaft and the exhaust camshaft sprockets, *must* be kept taut, without altering the position either of the crankshaft or of the camshaft(s) - if necessary, the position of the camshaft sprockets can be altered by rotating each on its camshaft (which remains fixed by the aligning tool). Where the sprocket is still fastened, use the holding tool described above to prevent the sprocket from rotating while its retaining bolt is slackened - the sprocket can then be rotated on the camshaft until the belt will slip into place; retighten the sprocket bolt.

20 When the belt is in place, slacken the tensioner bolt gently until the spring pulls the tensioner against the belt; the tensioner should be retained correctly against the timing belt inner shield and cylinder head, but must be just free to respond to changes in belt tension (see illustration).

21 Tighten both camshaft sprocket bolts (or check that they are tight, as applicable) and remove the camshaft-aligning tool. Temporarily refit the crankshaft pulley, and rotate the crankshaft through two full turns clockwise to settle and tension the timing belt, returning the crankshaft to the TDC position described previously. Refit the camshaft-aligning tool; it should slip into place as described in paragraph 8. If all is well, proceed to paragraph 24 below.

22 If one camshaft is only just out of line, fit the forked holding tool to its sprocket, adjust its position as required, and check that any slack created has been taken up by the tensioner; rotate the crankshaft through two further turns clockwise, and refit the camshaft-aligning tool to check that it now fits as it should. If all is well, proceed to paragraph 24 below.

23 If either camshaft is significantly out of line, use the holding tool to prevent its sprocket from rotating while its retaining bolt

is slackened - the camshaft can then be rotated (gently and carefully, using an open-ended spanner) until the camshaft-aligning tool will slip into place; take care not to disturb the relationship of the sprocket to the timing belt. Without disturbing the sprocket's new position on the camshaft, tighten the sprocket bolt to its specified torque wrench setting (see illustration). Remove the camshaft-aligning tool, rotate the crankshaft through two further turns clockwise, and refit the tool to check that it now fits as it should.

24 When the timing belt has been settled at its correct tension, and the camshaft-aligning tool fits correctly when the crankshaft pulley notches are exactly aligned, tighten the tensioner bolt to its specified torque wrench setting (see illustration). Fitting the forked holding tool to the spokes of each sprocket in turn, check that the sprocket bolts are tightened to their specified torque wrench setting. Remove the camshaft-aligning tool, rotate the crankshaft through two further turns clockwise, and refit the tool to make a final check that it fits as it should.

25 The remainder of the reassembly procedure is the reverse of removal, ensuring that all fasteners are tightened to the specified torque.

9 Timing belt tensioner and sprockets - removal, inspection and refitting



Tensioner

Note: If the tensioner is being removed for the first time since the vehicle left the factory, a tensioner spring and retaining pin must be obtained for fitting on reassembly.

1 While it is possible to reach the tensioner once the timing belt upper and middle covers only have been removed, the whole procedure outlined below must be followed, to ensure that the valve timing is correctly reset once the belt's tension has been disturbed.

2 Release the tension from the timing belt as described in Section 8, paragraphs 1 to 12.

3 Unscrew the tensioner bolt and withdraw

the tensioner, unhooking the spring, if fitted (see illustration). Check the tensioner spring, and renew it if there is any doubt about its condition.

4 On reassembly, if it is being fitted for the first time, screw the timing belt tensioner spring retaining pin into the cylinder head, tightening it to the specified torque wrench setting. Hook the spring onto the pin and the tensioner backplate, then refit the tensioner, engaging its backplate on the locating peg.

5 Use an Allen key inserted into its centre to rotate the tensioner as far as possible against spring tension, then tighten the bolt to secure the tensioner.

6 Reassemble, checking the camshaft alignment (valve timing) and setting the timing belt tension, as described in paragraphs 20 to 25 of Section 8.

Camshaft and crankshaft sprockets

7 While it may be possible to remove any of these sprockets once the relevant belt covers have been removed, the complete timing belt removal/refitting procedure (see Section 8) must be followed, to ensure that the valve timing is correctly reset once the belt's tension has been disturbed.

8 With the timing belt removed, the camshaft sprockets can be detached once their retaining bolts have been unscrewed as described in paragraph 16 of Section 8. The crankshaft sprocket can be pulled off the end of the crankshaft, once the crankshaft pulley



9.3 Removing timing belt tensioner



9.8 "FRONT" marking on outside face of crankshaft toothed pulley - note which way round thrustwasher behind is fitted

and the timing belt have been removed. Note the "FRONT" marking identifying the sprocket's outboard face, and the thrustwasher behind it; note which way round the thrustwasher is fitted (see illustration). Note the sprocket-locating Woodruff key; if this is loose, it should be removed for safe storage with the sprocket.

9 Check the sprockets as described in paragraph 14 of Section 8.

10 Refitting is the reverse of the removal procedure.

Timing belt guide pulleys

11 Remove the timing belt covers (see Section 7).

12 Unbolt and withdraw the pulley(s); check their condition as described in paragraph 14 of Section 8.

13 Refitting is the reverse of the removal procedure; tighten the pulley bolts to the specified torque wrench setting.

10 Camshaft oil seals - renewal



Note: While it is possible to reach either oil seal, once the respective sprocket has been removed (see Section 9) to allow the seal to be prised out, this procedure is not recommended. Not only are the seals very soft, making this difficult to do without risk of



10.5 Using socket and toothed pulley bolt to install camshaft oil seal

damage to the seal housing, but it would be very difficult to ensure that the valve timing and the timing belt's tension, once disturbed, are correctly reset. Owners are advised to follow the whole procedure outlined below.

1 Release the tension from the timing belt as described in Section 8, paragraphs 1 to 12.

Note: If the timing belt is found to be contaminated by oil, remove it completely as described, then renew the oil seal (see below). Wash down the engine timing belt area and all related components, to remove all traces of oil. Fit a new belt on reassembly.

2 If the timing belt is still clean, slip it off the sprocket, taking care not to twist it too sharply; use the fingers only to handle the belt. Do not rotate the crankshaft until the timing belt is refitted. Cover the belt, and secure it so that it is clear of the working area and cannot slip off the remaining sprocket.

3 Unfasten the sprocket bolt and withdraw the sprocket (see Section 9).

4 Unbolt the camshaft right-hand bearing cap, and withdraw the defective oil seal. Clean the seal housing, and polish off any burrs or raised edges, which may have caused the seal to fail in the first place.

5 To fit a new seal, Ford recommend the use of their service tool 21-009B, with a bolt (10 mm thread size, 70 mm long) and a washer, to draw the seal into place when the camshaft bearing cap is bolted down; a substitute can be made using a suitable socket (see illustration). Grease the seal lips and periphery to ease installation, and draw

the seal into place until it is flush with the housing/bearing cap outer edge. Refit the bearing cap, using sealant and tightening the cap bolts as described in Section 11.

6 For most owners, the simplest answer will be to grease the seal lips, and to slide it onto the camshaft (until it is flush with the housing's outer edge). Refit the bearing cap, using sealant and tightening the cap bolts as described in Section 11 (see illustration). Take care to ensure that the seal remains absolutely square in its housing, and is not distorted as the cap is tightened down.

7 Refit the sprocket to the camshaft, tightening the retaining bolt loosely, then slip the timing belt back onto the sprocket (refer to paragraphs 16 and 19 of Section 8) and tighten the bolt securely.

8 The remainder of the reassembly procedure, including checking the camshaft alignment (valve timing) and setting the timing belt tension, is as described in paragraphs 20 to 25 of Section 8.

11 Camshafts and hydraulic tappets - removal, inspection and refitting



Removal

1 Release the tension from the timing belt as described in Section 8, paragraphs 1 to 12.

2 Either remove the timing belt completely (Section 8, paragraphs 13 and 14) or slip it off the camshaft sprockets, taking care not to twist it too sharply; use the fingers only to handle the belt. Cover the belt, and secure it so that it is clear of the working area. Do not rotate the crankshaft until the timing belt is refitted.

3 Unfasten the sprocket bolts as described in Section 8, paragraph 16, and withdraw the sprockets; while both are the same and could be interchanged, it is good working practice to mark them so that each is refitted only to its original location (see illustration).

4 Working in the sequence shown, slacken progressively, by half a turn at a time, the camshaft bearing cap bolts (see illustration). Work only as described, to release gradually



10.6 Alternatively, seal can be inserted when camshaft bearing cap is unbolted



11.3 Using forked holding tool while camshaft toothed pulley bolt is slackened

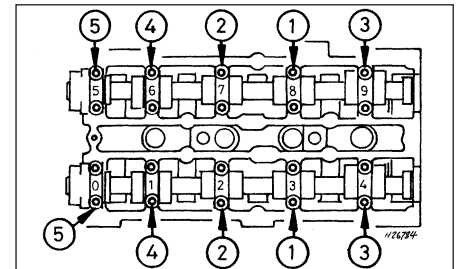

11.4 Camshaft bearing cap slackening sequence

Note: Viewed from front of vehicle, showing bearing cap numbers



11.5a Note locating dowels when removing camshaft bearing caps



11.5b Inlet camshaft has lobe for camshaft position sensor

and evenly the pressure of the valve springs on the caps.

5 Withdraw the caps, noting their markings and the presence of the locating dowels, then remove the camshafts and withdraw their oil seals. The inlet camshaft can be identified by the reference lobe for the camshaft position sensor; therefore, there is no need to mark the camshafts (see illustrations).

6 Obtain sixteen small, clean containers, and number them 1 to 16. Using a rubber sucker, withdraw each hydraulic tappet in turn, invert it to prevent oil loss, and place it in its respective container, which should then be filled with clean engine oil (see illustrations). Do not interchange the hydraulic tappets, or the rate of wear will be much increased. Do not allow them to lose oil, or they will take a long time to refill on restarting the engine, resulting in incorrect valve clearances.

Inspection

7 With the camshafts and hydraulic tappets removed, check each for signs of obvious wear (scoring, pitting etc) and for ovality, and renew if necessary.

8 Measure the outside diameter of each tappet (see illustration) - take measurements at the top and bottom of each tappet, then a second set at right-angles to the first; if any measurement is significantly different from the others, the tappet is tapered or oval and must

be renewed. If the necessary equipment is available, measure the inside diameter of the corresponding cylinder head bore. Compare the measurements obtained to those given in the Specifications Section of this Chapter; if the tappets or the cylinder head bores are excessively worn, new tappets and/or a new cylinder head will be required.

9 If the engine's valve components have sounded noisy, particularly if the noise persists after initial start-up from cold, there is reason to suspect a faulty hydraulic tappet. Only a good mechanic experienced in these engines can tell whether the noise level is typical, or if renewal of one or more of the tappets is warranted. If faulty tappets are diagnosed, and the engine's service history is unknown, it is always worth trying the effect of renewing the engine oil and filter (see Chapter 1), using *only* good-quality engine oil of the recommended viscosity and specification, before going to the expense of renewing any of the tappets - refer also to the advice in Section 5 of this Chapter.

10 Visually examine the camshaft lobes for score marks, pitting, galling (wear due to rubbing) and evidence of overheating (blue, discoloured areas). Look for flaking away of the hardened surface layer of each lobe. If any such signs are evident, renew the component concerned.

11 Examine the camshaft bearing journals and the cylinder head bearing surfaces for signs of obvious wear or pitting. If any such signs are evident, renew the component concerned.

12 Using a micrometer, measure the diameter of each journal at several points. If the diameter of any one journal is less than the specified value, renew the camshaft.

13 To check the bearing journal running clearance, remove the hydraulic tappets, use a suitable solvent and a clean lint-free rag to clean carefully all bearing surfaces, then refit the camshafts and bearing caps with a strand of Plastigauge across each journal. Tighten the bearing cap bolts to the specified torque wrench setting (do not rotate the camshafts), then remove the bearing caps and use the scale provided to measure the width of the compressed strands. Scrape off the Plastigauge with your fingernail or the edge of a credit card - don't scratch or nick the journals or bearing caps.

14 If the running clearance of any bearing is found to be worn to beyond the specified service limits, fit a new camshaft and repeat the check; if the clearance is still excessive, the cylinder head must be renewed.

15 To check camshaft endfloat, remove the hydraulic tappets, clean the bearing surfaces carefully, and refit the camshafts and bearing



11.6a Removing hydraulic tappets

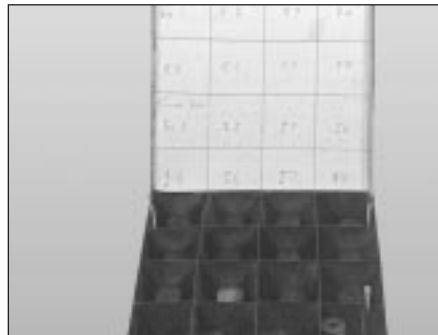

11.6b Hydraulic tappets must be stored as described in text

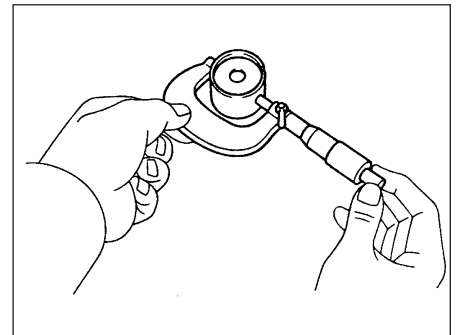

11.8 Use a micrometer to measure diameter of hydraulic tappets

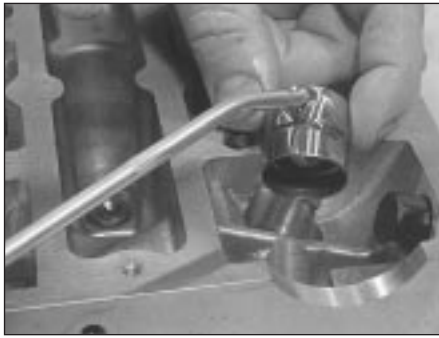

11.17 Oil liberally when refitting hydraulic tappets



11.19 Apply sealant to mating surface of camshaft right-hand bearing caps

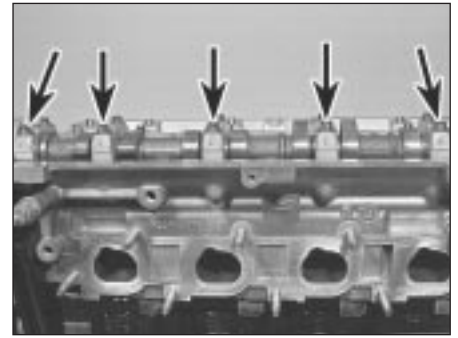

11.20 Etched marks on camshaft bearing caps must be arranged as shown, and face outwards

caps. Tighten the bearing cap bolts to the specified torque wrench setting, then measure the endfloat using a DTI (Dial Test Indicator, or dial gauge) mounted on the cylinder head so that its tip bears on the camshaft right-hand end.

16 Tap the camshaft fully towards the gauge, zero the gauge, then tap the camshaft fully away from the gauge, and note the gauge reading. If the endfloat measured is found to be at or beyond the specified service limit, fit a new camshaft and repeat the check; if the clearance is still excessive, the cylinder head must be renewed.

Refitting

17 On reassembly, liberally oil the cylinder head hydraulic tappet bores and the tappets (see illustration). Note that if new tappets are being fitted, they must be charged with clean engine oil before installation. Carefully refit the tappets to the cylinder head, ensuring that each tappet is refitted to its original bore, and is the correct way up. Some care will be required to enter the tappets squarely into their bores.

18 Liberally oil the camshaft bearings and lobes. Ensuring that each camshaft is in its original location, refit the camshafts, locating each so that the slot in its left-hand end is approximately parallel to, and just above, the cylinder head mating surface.

19 Ensure that the locating dowels are

pressed firmly into their recesses, and check that all mating surfaces are completely clean, unmarked and free from oil. Apply a thin film of suitable sealant (Ford recommend Loctite 518) to the mating surfaces of each camshaft's right-hand bearing cap (see illustration). Referring to paragraph 6 of Section 10, some owners may wish to fit the new camshaft oil seals at this stage.

20 All camshaft bearing caps have a single-digit identifying number etched on them (see illustration). The exhaust camshaft's bearing caps are numbered in sequence 0 to 4, the inlet's 5 to 9; see illustration 11.21a for details. Each cap is to be fitted so that its numbered side faces outwards, to the front (exhaust) or to the rear (inlet).

21 Ensuring that each cap is kept square to the cylinder head as it is tightened down, and working in the sequence shown, tighten the camshaft bearing cap bolts slowly and by one turn at a time, until each cap touches the cylinder head (see illustration). Next, go round again in the same sequence, tightening the bolts to the first stage torque wrench setting specified, then once more, tightening them to the second stage setting. Work only as described, to impose gradually and evenly the pressure of the valve springs on the caps. Fit the camshaft-aligning tool; it should slip into place as described in paragraph 8 of Section 8 (see illustration).

22 Wipe off all surplus sealant, so that none is left to find its way into any oilways. Follow

the sealant manufacturer's instructions as to the time needed for curing; usually, at least an hour must be allowed between application of the sealant and starting the engine.

23 If using Ford's recommended procedure, fit new oil seals to the camshafts as described in paragraph 5 of Section 10.

24 Using the marks and notes made on dismantling to ensure that each is refitted to its original camshaft, refit the sprockets to the camshafts, tightening the retaining bolts loosely. Slip the timing belt back onto the sprockets (refer to paragraph 19 of Section 8) and tighten the bolts securely - use the forked holding tool described in paragraph 16 of Section 8.

25 The remainder of the reassembly procedure, including checking the camshaft alignment (valve timing) and setting the timing belt tension, is as described in paragraphs 15 to 25 of Section 8.

12 Cylinder head - removal and refitting



Removal

Note: The following text assumes that the cylinder head will be removed with both inlet and exhaust manifolds attached. This simplifies the procedure, but makes it a bulky and heavy assembly to handle - an engine hoist will be required, to prevent the risk of injury, and to prevent damage to any delicate components as the assembly is removed and refitted. If it is wished first to remove the manifolds, refer to Chapter 4D, then amend the following procedure accordingly.

1 Depressurise the fuel system (see Chapter 4D).

2 Disconnect the battery negative (earth) lead (refer to Chapter 5A, Section 1).

3 Refer to Chapter 4D and remove the air inlet components.

4 Equalise the pressure in the fuel tank by removing the filler cap, then undo the fuel feed and return lines connecting the engine to the chassis (see Chapter 4D). Plug or cap all open fittings.

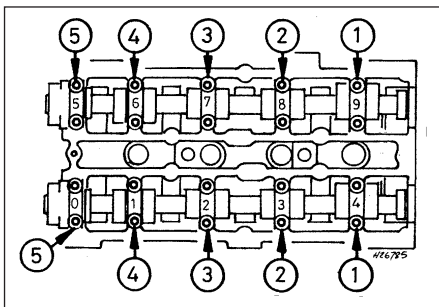

11.21a Camshaft bearing cap tightening sequence

Note: View from front of vehicle - locate bearing caps according to etched numbers, aligned as described in text



11.21b Fit camshaft-aligning tool to set TDC position while camshaft toothed pulleys are refitted



12.7a Unplug engine wiring loom connector alongside the inlet manifold



12.7b Unplug connectors (arrowed) to disconnect ignition coil wiring



12.13 Disconnect all coolant hoses from thermostat housing

**HAYNES
HINT**

Whenever you disconnect any vacuum lines, coolant or emissions hoses, wiring connectors and fuel lines, always label them clearly, so that they can be correctly reassembled. Masking tape and/or a touch-up paint applicator work well for marking items. Take instant photos, or sketch the locations of components and brackets.

5 Disconnect the accelerator cable from the throttle linkage as described in Chapter 4D. Secure the cable clear of the engine/transmission.

6 Remove the auxiliary drivebelt (see Chapter 1).

7 Remove the three screws securing the wiring "rail" to the rear of the manifold. Releasing its wire clip, unplug the large electrical connector (next to the fuel pressure regulator) to disconnect the engine wiring from the main loom (see illustration). Unplug the electrical connectors on each side of the ignition coil, and the single connector from beneath the front of the thermostat housing, to disconnect the coil and coolant temperature gauge sender wiring (see illustration).

8 Marking or labelling them as they are unplugged, disconnect the vacuum hoses as follows:

- a) One from the rear of the throttle housing (only the one hose - there is no need to disconnect the second hose running to the fuel pressure regulator).
- b) One from the union on the inlet manifold's left-hand end.
- c) The braking system vacuum servo unit hose (see Chapter 9 for details).

9 Unbolt the engine earth lead from the cylinder head lifting eye.

10 Unbolt both parts of the exhaust manifold heat shield. Either remove the dipstick and tube, or swing them out of the way.

11 Unscrew the pulse-air filter housing retaining bolt, then disconnect its vacuum hose.

12 Drain the cooling system (see Chapter 1).

13 Disconnect all coolant hoses from the thermostat housing (see illustration).

14 Unscrew the two nuts to disconnect the exhaust system front downpipe from the manifold (Chapter 4B); disconnect the oxygen sensor wiring, so that it is not strained by the weight of the exhaust system.

15 Remove the timing belt and both camshafts (see Sections 8 and 11); if the cylinder head is to be dismantled, withdraw the hydraulic tappets.

16 Remove the timing belt inner shield (see Section 7).

17 Working in the reverse of the sequence shown in illustration 12.28a, slacken the ten cylinder head bolts progressively and by one turn at a time; a Torx key (TX 55 size) will be required. Remove each bolt in turn, and ensure that new replacements are obtained for reassembly; these bolts are subjected to severe stresses and so **must** be renewed, regardless of their apparent condition, whenever they are disturbed.

18 Lift the cylinder head away; use assistance if possible, as it is a heavy assembly. If necessary, grip the manifolds and rock it free from the location dowels on the top face of the cylinder block. Do not attempt to tap it sideways or lever between the head and the block top face. Remove the gasket, noting the two dowels, and discard it.

Preparation for refitting

19 The mating faces of the cylinder head and cylinder block must be perfectly clean before

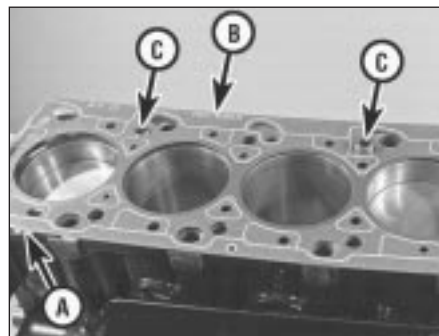

12.23 Ensuring protruding tooth (or teeth) "A" are at front and marking "B" is upwards, locate new cylinder head gasket on dowels "C"

refitting the head. Use a hard plastic or wood scraper to remove all traces of gasket and carbon; also clean the piston crowns. Take particular care during the cleaning operations, as aluminium alloy is easily damaged. Also, make sure that the carbon is not allowed to enter the oil and water passages - this is particularly important for the lubrication system, as carbon could block the oil supply to the engine's components. Using adhesive tape and paper, seal the water, oil and bolt holes in the cylinder block.

**HAYNES
HINT**

To prevent carbon entering the gap between the pistons and bores, smear a little grease in the gap. After cleaning each piston, use a small brush to remove all traces of grease and carbon from the gap, then wipe away the remainder with a clean rag.

20 Check the mating surfaces of the cylinder block and the cylinder head for nicks, deep scratches and other damage. If slight, they may be removed carefully with a file, but if excessive, machining may be the only alternative to renewal.

21 If warpage of the cylinder head gasket surface is suspected, use a straight-edge to check it for distortion. Refer to Part D of this Chapter if necessary.

Refitting

22 Wipe clean the mating surfaces of the cylinder head and cylinder block. Check that the two locating dowels are in position in the cylinder block, and that all cylinder head bolt holes are free from oil.

23 Position a new gasket over the dowels on the cylinder block surface, so that the "TOP/OBEN" mark is uppermost, and with the tooth (or teeth, according to engine size) protruding from the front edge (see illustration).

24 Temporarily refit the crankshaft pulley, and rotate the crankshaft anti-clockwise so that No 1 cylinder's piston is lowered to approximately 20 mm before TDC, thus avoiding any risk of valve/piston contact and damage during reassembly.

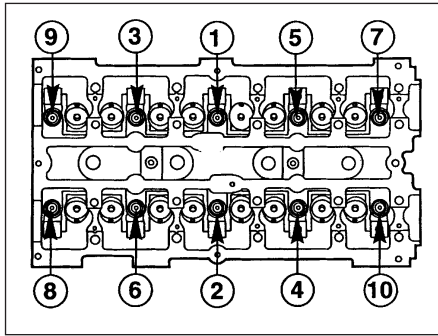

12.28a Cylinder head bolt tightening sequence

Note: View from rear of vehicle

25 As the cylinder head is such a heavy and awkward assembly to refit with manifolds, it is helpful to make up a pair of guide studs from two 10 mm (thread size) studs approximately 90 mm long, with a screwdriver slot cut in one end - two old cylinder head bolts with their heads cut off would make a good starting point. Screw these guide studs, screwdriver slot upwards to permit removal, into the bolt holes at diagonally-opposite corners of the cylinder block surface (or into those where the locating dowels are fitted); ensure that approximately 70 mm of stud protrudes above the gasket.

26 Refit the cylinder head, sliding it down the guide studs (if used) and locating it on the dowels. Unscrew the guide studs (if used) when the head is in place.

27 Fit the new cylinder head bolts dry (*do not* oil their threads); carefully enter each into its hole and screw it in, by hand only, until finger-tight.

28 Working progressively and in the sequence shown, use first a torque wrench, then an ordinary socket extension bar and an angle gauge, to tighten the cylinder head bolts in the stages given in the Specifications Section of this Chapter (**see illustrations**).

Note: Once tightened correctly, following this procedure, the cylinder head bolts do not require check-tightening, and must **not** be re-torqued.

29 Refit the hydraulic tappets (if removed), the camshafts, their oil seals and sprockets (see Sections 11, 10 and 9, as appropriate). Temporarily refit the crankshaft pulley, and rotate the crankshaft clockwise to return the pulley notches to the TDC position described in Section 3.

30 Refit the earth lead to the lifting eye

31 Refit the timing belt and covers, checking the camshaft alignment (valve timing) and setting the timing belt tension, as described in Section 8.

32 The remainder of reassembly is the reverse of the removal procedure, noting the following points:

- Tighten all fasteners to the torque wrench settings specified.
- Refill the cooling system, and top-up the



12.28b Tightening cylinder head bolts (Stages 1 and 2) using torque wrench . . .



12.28c . . . and to Stage 3 using angle gauge

- engine oil (see Chapter 1 and "Weekly Checks").
- Check all disturbed joints for signs of oil or coolant leakage, once the engine has been restarted and warmed-up to normal operating temperature.
 - If the power steering hoses where disconnected, bleed the system as described in Chapter 10 after reconnection.

13 Sump - removal and refitting



Removal

Note: The full procedure outlined below must be followed, so that the mating surfaces can be cleaned and prepared to achieve an oil-tight joint on reassembly, and so that the sump can be aligned correctly; depending on your skill and experience, and the tools and facilities available, it may be that this task can be carried out only with the engine removed from the vehicle. Note that the sump gasket must be renewed whenever it is disturbed.

1 Disconnect the battery negative (earth) lead (refer to Chapter 5A, Section 1).

2 Drain the engine oil, then clean and refit the engine oil drain plug, tightening it to the specified torque wrench setting. Although not strictly necessary as part of the dismantling procedure, owners are advised to remove and discard the oil filter, so that it can be renewed with the oil (see Chapter 1).

3 Refer to Chapter 5A and remove the starter motor.

4 Remove the auxiliary drivebelt cover (see Chapter 1).

5 Unplug the electrical connector(s) to disconnect the oxygen sensor.

6 Unscrew the nuts to disconnect the exhaust system front downpipe from the manifold, then either unhook all the system's rubber mountings and withdraw the complete exhaust system from under the vehicle, or remove only the downpipe/catalytic converter (see Chapter 4E for details).

7 Unscrew the sump-to-transmission bolts, also any securing the engine/transmission lower adapter plate.

8 Progressively unscrew the sump retaining bolts. Break the joint by striking the sump with the palm of the hand, then lower the sump and withdraw it with the engine/transmission lower adapter plate (where fitted); note the presence of any shims between the sump and transmission.

9 Remove and discard the sump gasket; this must be renewed as a matter of course whenever it is disturbed.

10 While the sump is removed, take the opportunity to remove the oil pump pick-up/strainer pipe and to clean it (see Section 14).

Refitting

11 On reassembly, thoroughly clean and degrease the mating surfaces of the cylinder block/crankcase and sump, then use a clean rag to wipe out the sump and the engine's interior. If the oil pump pick-up/strainer pipe was removed, fit a new gasket and refit the pipe, tightening its screws to the specified torque wrench setting. Fit the new gasket to the sump mating surface so that the gasket fits into the sump groove (**see illustration**).

12 If the sump is being refitted with the engine/transmission still connected and in the vehicle, proceed as follows:

- Check that the mating surfaces of the sump, the cylinder block/crankcase and



13.11 Ensure gasket is located correctly in sump groove



13.13a Apply sealant (arrowed) as directed when refitting sump

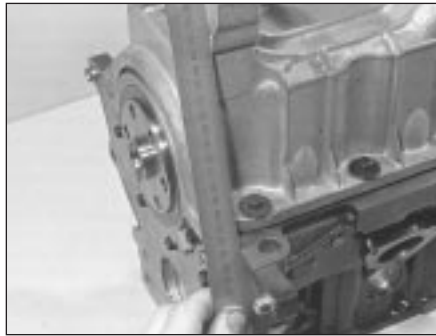

13.13b Checking alignment of sump with cylinder block/crankcase

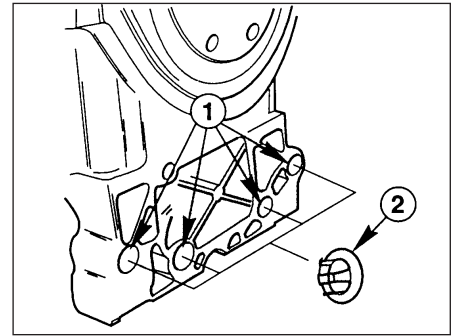

13.13c Sump-to-cylinder block/crankcase alignment shims

1 Fitting points on sump 2 Shim

the transmission are absolutely clean and flat. Any shims found on removal of the sump must be refitted in their original locations.

- b) Apply a thin film of suitable sealant (Ford recommend Hylsil 102) to the junctions of the cylinder block/crankcase with the oil pump and the crankshaft left-hand oil seal carrier. Without delay - the sump bolts must be fully tightened within 10 to 20 minutes of applying the sealant - offer up the sump and engine/transmission lower adapter plate, and refit the bolts, tightening them lightly at first.
- c) Ensuring that the engine/transmission lower adapter plate is correctly located, firmly press the sump against the transmission, and tighten the transmission-to-sump (ie, engine) bolts to the specified torque wrench setting.
- d) Without disturbing the position of the sump, and working in a diagonal sequence from the centre outwards, tighten the sump bolts to the specified torque wrench setting.
- e) Proceed to paragraph 14.

13 If the sump is being refitted with the engine and transmission separated (in or out of the vehicle), proceed as follows:

- a) Apply a thin film of suitable sealant (Ford recommend Hylsil 102) to the junctions of the cylinder block/crankcase with the oil pump and the crankshaft left-hand oil

seal carrier (see illustration). Without delay - the sump bolts must be fully tightened within 10 to 20 minutes of applying the sealant - offer up the sump to the cylinder block/crankcase, and insert the sump bolts, tightening them lightly at first.

- b) Using a suitable straight edge to check alignment across the flat-machined faces of each, move the sump as necessary so that its left-hand face - including any shims found on removal - is flush with that of the cylinder block/crankcase (see illustration). Without disturbing the position of the sump, and working in a diagonal sequence from the centre outwards, tighten the sump bolts to the specified torque wrench setting.
- c) Check again that both faces are flush before proceeding; if necessary, unbolt the sump again, clean the mating surfaces, and repeat the full procedure to ensure that the sump is correctly aligned.
- d) If it is not possible to achieve exact alignment by moving the sump, shims are available in thicknesses of 0.25 mm (colour-coded yellow) or 0.50 mm (colour-coded black) to eliminate the discrepancy (see illustration).

14 The remainder of reassembly is the reverse of the removal procedure, noting the following points.

- a) Tighten all fasteners to the torque wrench settings specified.

b) Always renew any self-locking nuts disturbed on removal.

c) Refill the cooling system (see Chapter 1).

d) Refill the engine with oil, remembering that you are advised to fit a new filter (see Chapter 1).

e) Check for signs of oil or coolant leaks once the engine has been restarted and warmed-up to normal operating temperature.

14 Oil pump - removal, inspection and refitting



2C

Removal

Note: While this task is theoretically possible when the engine is in place in the vehicle, in practice, it requires so much preliminary dismantling, and is so difficult to carry out due to the restricted access, that owners are advised to remove the engine from the vehicle first. Note, however, that the oil pump pressure relief valve can be removed with the engine in situ - see paragraph 8.

1 Remove the timing belt (see Section 8).

2 Withdraw the crankshaft sprocket and the thrustwasher behind it, noting which way round the thrustwasher is fitted (see Section 9).

3 Remove the sump (see Section 13).

4 Undo the screws securing the oil pump pick-up/strainer pipe to the pump, then unscrew the nut and withdraw the oil pump pick-up/strainer pipe. Discard the gasket.

5 Unbolt the pump from the cylinder block/crankcase (see illustration). Withdraw and discard the gasket, and remove the crankshaft right-hand oil seal. Thoroughly clean and degrease all components, particularly the mating surfaces of the pump, the sump, and the cylinder block/crankcase.

Inspection

6 Unscrew the Torx screws, and remove the pump cover plate; noting any identification marks on the rotors, withdraw the rotors (see illustration).

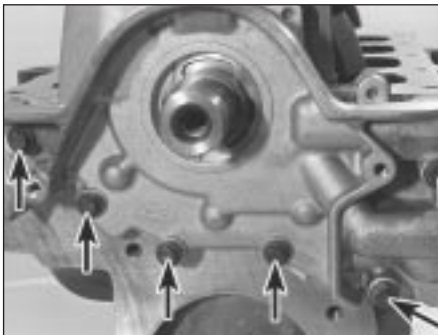

14.5 Unscrew bolts (arrowed) to remove oil pump



14.6 Withdrawing oil pump inner rotor



14.9a Unscrew threaded plug - seen through right-hand wheel arch . . .



14.9b . . . to withdraw oil pressure relief valve spring and plunger



14.12 Use new gasket when refitting oil pump

7 Inspect the rotors for obvious signs of wear or damage, and renew if necessary; if either rotor, the pump body, or its cover plate are scored or damaged, the complete oil pump assembly must be renewed.

8 The oil pressure relief valve can be dismantled, if required, without disturbing the pump. Chock the rear wheels then jack up the front of the car and support it on axle stands (see *"Jacking and Vehicle Support"*). Remove the front right-hand roadwheel and auxiliary drivebelt cover (see Chapter 1) to provide access to the valve.

9 Unscrew the threaded plug, and recover the valve spring and plunger (see illustrations). If the plug's sealing O-ring is worn or damaged, a new one must be obtained, to be fitted on reassembly.

10 Reassembly is the reverse of the

dismantling procedure; ensure the spring and valve are refitted the correct way round, and tighten the threaded plug securely.

Refitting

11 The oil pump must be primed on installation, by pouring clean engine oil into it, and rotating its inner rotor a few turns.

12 Using grease to stick the new gasket in place on the cylinder block/crankcase, and rotating the pump's inner rotor to align with the flats on the crankshaft, refit the pump and insert the bolts, tightening them lightly at first (see illustration).

13 Using a suitable straight edge and feeler gauges, check that the pump is both centred exactly around the crankshaft, and aligned squarely so that its (sump) mating surface is exactly the same amount - between 0.3 and 0.8 mm - below that of the cylinder block/crankcase on each side of the crankshaft (see illustration). Being careful not to disturb the gasket, move the pump into the correct position, and tighten its bolts to the specified torque wrench setting.

14 Check that the pump is correctly located; if necessary, unbolt it again, and repeat the full procedure to ensure that the pump is correctly aligned.

15 Fit a new crankshaft right-hand oil seal (see Section 15).

16 Using grease to stick the gasket in place on the pump, refit the pick-up/strainer pipe, tightening its screws and nut to their specified torque wrench settings (see illustration).



14.13 Oil pump must be positioned accurately



14.16 Use new gasket when refitting oil pick-up pipe to pump



15.2 Driving out crankshaft right-hand oil seal

17 The remainder of reassembly is the reverse of the removal procedure, referring to the relevant text for details where required.

15 Crankshaft oil seals - renewal



Note: Don't try to prise these seals out without removing the oil pump or seal carrier - the seals are too soft, and the amount of space available is too small, for this to be possible without considerable risk of damage to the seal housing and/or the crankshaft journal. Follow exactly the procedure given below.

Right-hand seal

1 Remove the oil pump (see Section 14).

2 Drive the oil seal out of the pump from behind (see illustration).

3 Clean the seal housing and crankshaft, polishing off any burrs or raised edges, which may have caused the seal to fail in the first place.

4 Refit the oil pump (see Section 14). Grease the lips and periphery of the new seal, to ease installation.

5 To fit a new seal, Ford recommend the use of their service tool 21-093A, with the crankshaft pulley bolt, to draw the seal into place; an alternative can be arranged using a socket of suitable size, with a washer to match the crankshaft pulley bolt (see illustration).



15.5 Socket of correct size can be used to replace Ford service tool, drawing new seal into place as described



15.6 If seal is tapped into place as shown, exercise great care to prevent seal from being damaged or distorted

6 If such tools are not available, press the seal squarely into place by hand; tap it in until it is flush with the pump housing, using a soft-faced mallet and a socket with an outside diameter only slightly smaller than the seal's (see illustration). This approach requires great care, to ensure that the seal is fitted squarely, without distortion or damage.

7 Wash off any traces of oil. The remainder of reassembly is the reverse of the removal procedure, referring to the relevant text for details where required. Check for signs of oil leakage when the engine is restarted.

Left-hand seal

8 Remove the transmission (see the relevant Part of Chapter 7).

9 Where appropriate, remove the clutch (Chapter 6).

10 Unbolt the flywheel/driveplate (see Section 17).

11 Remove the sump (see Section 13).

12 Unbolt the oil seal carrier (see illustration). Remove and discard its gasket.

13 Supporting the carrier evenly on wooden blocks, drive the oil seal out of the carrier from behind (see illustration).

14 Clean the seal housing and crankshaft, polishing off any burrs or raised edges, which may have caused the seal to fail in the first place. Clean also the mating surfaces of the cylinder block/crankcase and carrier, using a

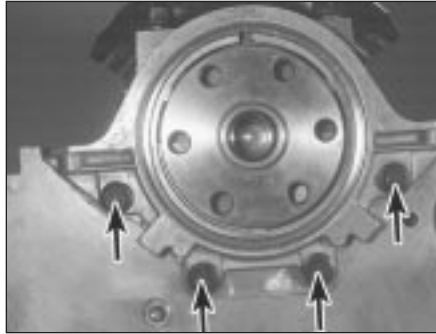

15.12 Unscrew bolts (arrowed) to remove crankshaft left-hand oil seal carrier . . .

scraper to remove all traces of the old gasket - be careful not to scratch or damage the material of either - then use a suitable solvent to degrease them.

15 Use grease to stick the new gasket in place on the cylinder block/crankcase, then offer up the carrier (see illustration).

16 Using a suitable straight edge and feeler gauges, check that the carrier is both centred *exactly* around the crankshaft, and aligned squarely so that its (sump) mating surface is exactly the same amount - between 0.3 and 0.8 mm - below that of the cylinder block/crankcase on each side of the crankshaft (see illustration). Being careful not to disturb the gasket, move the carrier into the correct position, and tighten its bolts to the specified torque wrench setting.

17 Check that the carrier is correctly located; if necessary, unbolt it again, and repeat the full procedure to ensure that the carrier is correctly aligned.

18 Ford's recommended method of seal fitting is to use service tool 21-141, with two flywheel bolts to draw the seal into place. If this is not available, make up a guide from a thin sheet of plastic or similar, lubricate the lips of the new seal and the crankshaft shoulder with grease, then offer up the seal, with the guide feeding the seal's lips over the crankshaft shoulder (see illustration). Press the seal evenly into its housing by hand only,



15.13 . . . and ensure that carrier is properly supported when driving out used oil seal - note notches provided in carrier for drift

and use a soft-faced mallet gently to tap it into place until it is flush with the surrounding housing.

19 Wipe off any surplus oil or grease; the remainder of the reassembly procedure is the reverse of dismantling, referring to the relevant text for details where required. Check for signs of oil leakage when the engine is restarted.

16 Engine/transmission mountings - inspection and renewal



Inspection

1 The engine/transmission mountings seldom require attention, but broken or deteriorated mountings should be renewed immediately, or the added strain placed on the driveline components may cause damage or wear.

2 During the check, the engine/transmission must be raised slightly, to remove its weight from the mountings.

3 Chock the rear wheels then jack up the front of the car and support it on axle stands (see *Jacking and Vehicle Support*). Position a jack under the sump, with a large block of wood between the jack head and the sump, then carefully raise the engine/transmission just enough to take the weight off the mountings.



15.15 Use new gasket when refitting left-hand oil seal carrier



15.16 Oil seal carrier must be positioned accurately

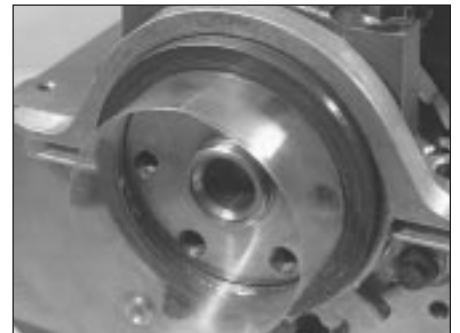

15.18 Using guide made from thin sheet of plastic to slide oil seal lips over crankshaft shoulder

4 Check the mountings to see if the rubber is cracked, hardened or separated from the metal components. Sometimes, the rubber will split right down the centre.

5 Check for relative movement between each mounting's brackets and the engine/transmission or body (use a large screwdriver or lever to attempt to move the mountings). If movement is noted, lower the engine and check-tighten the mounting fasteners.

Renewal

6 The engine mountings can be removed if the weight of the engine/transmission is supported by one of the following alternative methods.

7 Either support the weight of the assembly from underneath using a jack and a suitable piece of wood between the jack saddle and the sump or transmission (to prevent damage), or from above by attaching a hoist to the engine. A third method is to use a suitable support bar with end pieces which will engage in the water channel each side of the bonnet lid aperture. Using an adjustable hook and chain connected to the engine, the weight of the engine and transmission can then be taken from the mountings.

Engine front right-hand mounting

8 This mounting consists of a two-piece bracket bolted to the inner wing panel, connected by the bonded-rubber mounting itself to a (Y-shaped) bracket, bolted (via the alternator mounting bracket) to the cylinder block (see illustration).

9 Unscrew the three bolts securing the front right-hand mounting bracket to the alternator mounting bracket.

10 Unscrew the bolts securing the mounting bracket to the inner wing panel and chassis rail and withdraw the mounting assembly.



16.8 Engine front right-hand mounting

Engine rear right-hand mounting

11 This mounting consists of the bonded-rubber mounting secured to the inner wing panel by a (horizontal) bolt, accessible from within the wheel arch, and a (vertical) stud, the retaining nut of which is accessible from the engine compartment. The mounting is bolted to a bracket, which is in turn bolted to the cylinder block.

12 Unbolt the mounting from the body by unscrewing first the single nut (and washer) immediately to the rear of the timing belt cover, then the bolt in the wheel arch.

13 Unbolt the mounting from the cylinder block bracket and withdraw the mounting assembly.

Transmission bearer and mountings

14 On XR2i models, remove the front suspension crossmember as described in Chapter 10.

15 Unscrew and remove the two nuts securing the mountings (front and rear) to the transmission bearer

16 Support the transmission bearer, then undo and remove the four retaining bolts from the floorpan, two at the front and two at the rear, and lower the transmission bearer from the vehicle. Note plate fitment, as applicable, for reassembly.

17 To remove the mountings from the transmission, unscrew the upper bolt and lower stud (front mounting) or the three nuts (rear mounting) and withdraw the relevant mounting and bracket assembly from the transmission.

All mountings

18 Refitting of all mountings is a reversal of removal. Make sure that the original sequence of assembly of washers and plates is maintained.

19 Do not fully tighten any mounting bolts until they are all located. As the mounting bolts and nuts are tightened, check that the mounting rubbers do not twist.

17 Flywheel/driveplate - removal, inspection and refitting



Removal

1 Remove the transmission (see the relevant Part of Chapter 7).

2 Where appropriate, remove the clutch (Chapter 6).

3 Use a centre-punch or paint to make

alignment marks on the flywheel/driveplate and crankshaft, to ensure correct alignment during refitting.

4 Prevent the flywheel/driveplate from turning by locking the ring gear teeth, or by bolting a strap between the flywheel/driveplate and the cylinder block/crankcase. Slacken the bolts evenly until all are free.

5 Remove each bolt in turn, and ensure that new replacements are obtained for reassembly; these bolts are subjected to severe stresses, and so must be renewed, regardless of their apparent condition, whenever they are disturbed.

6 Noting the reinforcing plate (automatic transmission models only), withdraw the flywheel/driveplate; do not drop it - it is very heavy.

Inspection

7 Clean the flywheel/driveplate to remove grease and oil. Inspect the surface for cracks, rivet grooves, burned areas and score marks. Light scoring can be removed with emery cloth. Check for cracked and broken ring gear teeth. Lay the flywheel/driveplate on a flat surface, and use a straight edge to check for warpage.

8 Clean and inspect the mating surfaces of the flywheel/driveplate and the crankshaft. If the crankshaft left-hand seal is leaking, renew it (see Section 15) before refitting the flywheel/driveplate.

9 While the flywheel/driveplate is removed, clean carefully its inboard (right-hand) face, particularly the recesses which serve as the reference points for the crankshaft speed/position sensor. Clean the sensor's tip, and check that the sensor is securely fastened.

Refitting

10 On refitting, ensure that the engine/transmission adapter plate is in place (where necessary), then fit the flywheel/driveplate to the crankshaft so that all bolt holes align - it will fit only one way - check this using the marks made on removal. Do not forget the reinforcing plate (automatic transmission models).

11 Lock the flywheel/driveplate by the method used on dismantling. Working in a diagonal sequence to tighten them evenly, and increasing to the final amount in two or three stages, tighten the new bolts to the specified torque wrench setting.

12 The remainder of reassembly is the reverse of the removal procedure, referring to the relevant text for details where required.